

Commercial Vehicle Water Pump Series





Company Introduction 企业介绍

Founded in 1987, Ruili Group has more than 20 wholly-owned, holding and shareholding enterprises span manufacturing and service industries. The manufacturing industry of Ruili is mainly engaged in the research and development, manufacturing and sales of auto parts and rail transit parts. Rail transit parts manufactured by Ruili are widely used in CHSR, CRH, urban rail and metro. Ruili products featured in Beijing Olympic Games, Shanghai World Exposition, 60th and 70th National Day Parade, 70th Anniversary Parade of the Victory of the Anti-Japanese War, 90th Anniversary Parade of the Military Founding.

Ruili group has been named the China Top 100 Auto Parts Enterprises, the National Auto Parts Export Base, the Key High-tech Enterprise of National Torch Plan, the National Intellectual Property Demonstration Enterprise, the National Top 500 Private Enterprises, the Zhejiang Top 100 Manufacturing Industry Enterprises, the Zhejiang Leading Industry Enterprise, the Zhejiang Leading Innovation Enterprise, the Zhejiang Leading High-end Equipment Manufacturing Enterprise, the Zhejiang "Three Famous" Cultivate Pilot Enterprise, the Zhejiang Advanced Unit of Valuing and caring Talents.

Ruili under the instruction of thinking decide way out, strategic achieve future, detail decides success or failure, has formed a business pattern that manufacturing industry with professional management for diversified operation and investment, now has developed as an enterprise group that auto parts predominating also take the real estate, hotel services, business, trade, culture and education into account.



瑞立集团创办于**1987**年,旗下现有全资、控股、参股企业**20**余家,产业跨越制造业、服务业。集团二产板块主要从事汽车零部件、轨道车辆零部件的研发、制造和销售。瑞立制造的轨道车辆零部件在高铁、动车、城轨、地铁上广泛应用。北京奥运会、上海世博会、国庆**60**周年阅兵、抗战胜利**70**周年阅兵、建军**90**周年阅兵,国庆**70**周年阅兵大会上,都有瑞立产品的身影。

瑞立先后被命名为中国汽车零部件百强企业、国家汽车零部件出口基地企业、国家火炬计划重点高新技术企业、国家知识产权示范企业、全国民营企业**500**强、浙江省制造业百强、浙江省工业行业龙头骨干企业、浙江省创新型领军企业、浙江省高端装备制造业骨干企业、浙江省“三名”培育试点企业、浙江省“重才爱才”先进单位。

瑞立在“思路决定出路、战略成就未来、细节决定成败”的发展理念指引下,形成了“一业为主、适度多元经营,多元投资、专业管理”格局,现已经发展成为主营汽配,兼跨房地产、酒店服务、商业、贸易、文教等为一体的无区域企业集团。

Company introduction

- Established in July 1969, and joint venture with Asimco in 1994 (asimco 66%+ Langfang SASAC 34%)
- May 9, 2016 Ruili Group acquired 66% equity of Asimco (Ruili Group 66%+ Langfang SASAC 34%)
Main products: commercial vehicle air compressor, water pump
- Annual capacity: 1.6 million units/year air compressor, 1,000,000 units/year water pump
- Employees: 670

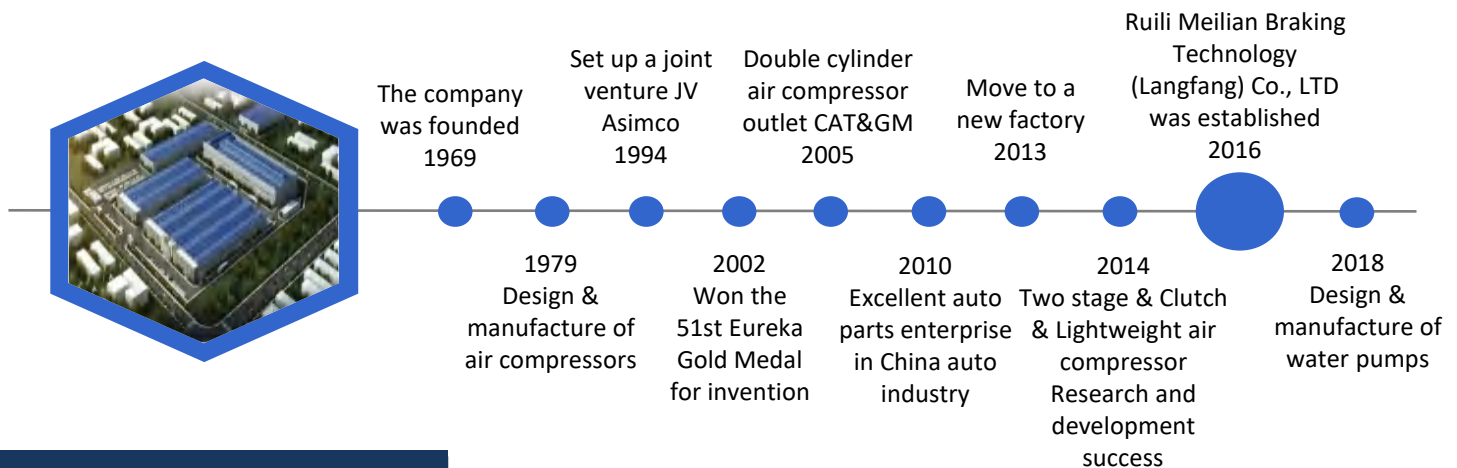

Ability to design

Water pump shell strength analysis
Abaqus/Hyperwork-one workstation

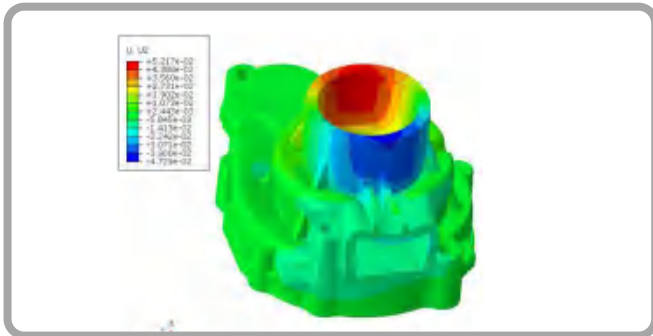

CAD – Product design
CATIA V5R19- Two workstations
Pro/E Creo, Twenty-one

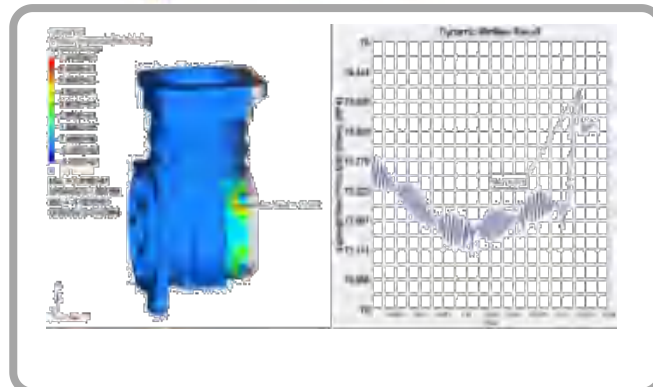
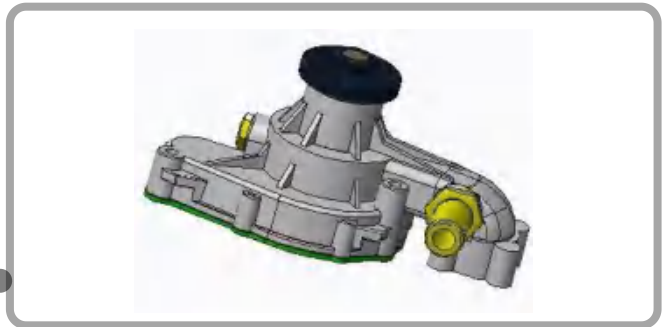

Strength analysis of air compressor cylinder block
Abaqus/Hyperwork-one workstation



CAD – Engineering drawing
CAXA - Thirty-four workstations

Water pump explosion chart

S500L1-1307100泵头分解图

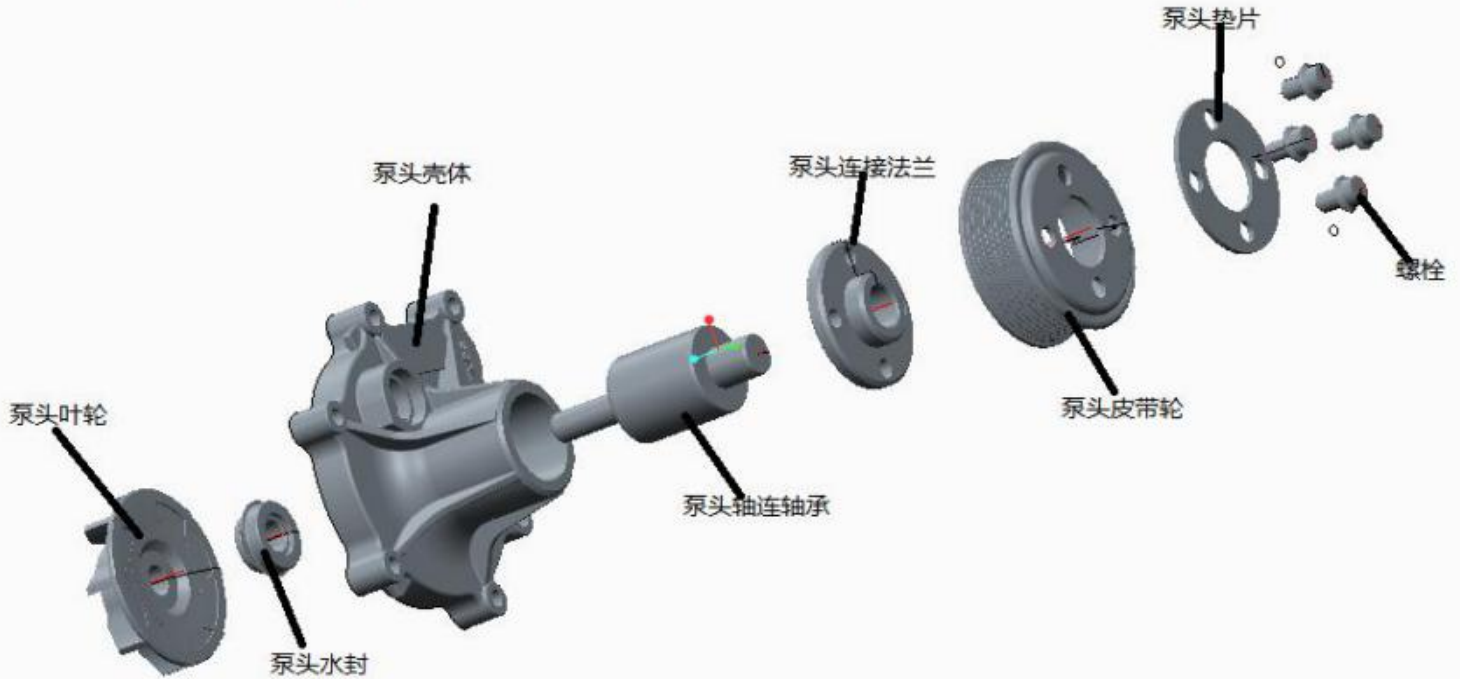

Product development trends

Normal product



Normal product



Electromagnetic clutch type



Electronic pump



The production line



Assembly line

The annual production capacity of pump is 400,000 units

- ★ Servo pressure test bench
- ★ Automatic airtight detection

Production process inspection equipment

Roughness & profile measuring instrument

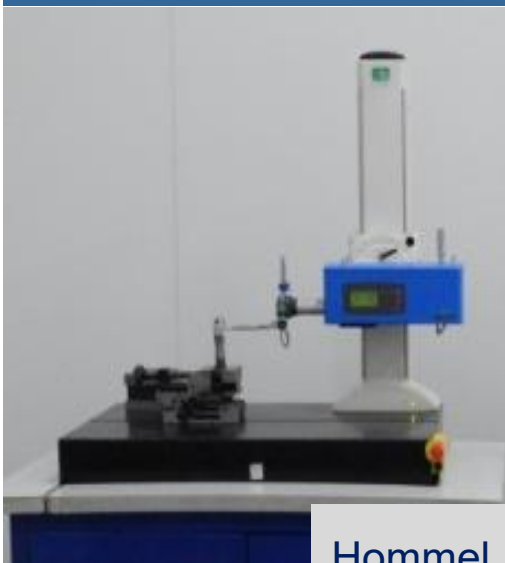

Hommel

Cylindricity measurement

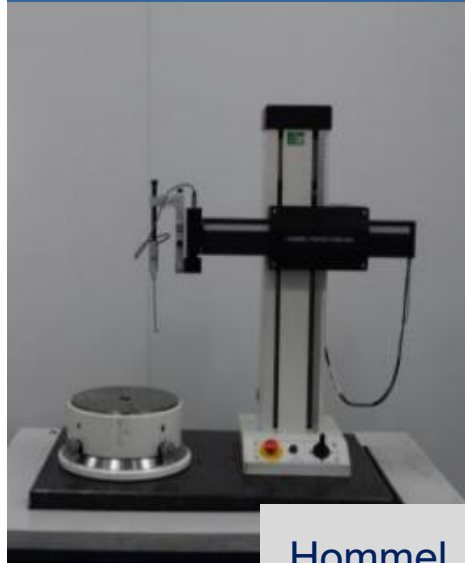

Hommel

Three coordinate measuring instrument



GHexagon

Performance verification

Water pump performance test bench



Water pump endurance test bench



System certification

Safety & Environment certification

认证证书

标准 **BS OHSAS 18001:2007**
证书登记号码 01 113 1532927

证书持有者:



瑞立美联制动技术(廊坊)有限公司
中华人民共和国河北省廊坊市
安次经济开发区安中路2号北区
邮编: 065099

认证范围: 汽车空气压缩机的设计和制造

证明完成了审核并满足了 BS OHSAS 18001:2007 标准的要求。

有效期: 证书有效期从 2018-12-31 至 2021-03-11。
此证书经过符合要求的监督审核保持有效。
初次发证始于 2015 年

2018-11-09

K. Jighe

TÜV Rheinland Cert GmbH
Am Grauen Stein 51105 Köln

www.tuv.com



认证证书

标准 **ISO 14001:2015**
证书登记号码 01 104 1532927

证书持有者:



瑞立美联制动技术(廊坊)有限公司
中华人民共和国河北省廊坊市
安次经济开发区安中路2号北区
邮编: 065099

认证范围: 汽车空气压缩机的设计和制造

证明完成了审核并满足了 ISO 14001:2015 标准的要求。

有效期: 证书有效期从 2018-12-31 至 2021-12-30。
此证书经过符合要求的监督审核保持有效。
初次发证始于 2015 年

2018-11-09

K. Jighe

TÜV Rheinland Cert GmbH
Am Grauen Stein 51105 Köln

www.tuv.com



Quality certification

认证证书

标准 **IATF 16949:2016**
(第 1 版, 2016-10-01)

证书登记号码 **01 111 1532927**

IATF 证书号码 **0417000**

证书持有者: **瑞立美联制动技术(廊坊)有限公司**
中国河北省廊坊市安次经济开发区安中路 2 号北区
邮编: 065099

认证范围: **空气压缩机和水泵的设计和制造**

证明完成了审核并满足了 IATF 16949:2016 标准的要求。

有效期: **证书有效期从 2021-08-12 至 2024-08-11。**

放行日: **2021-08-16**



24AO-QMC 01003

TÜV Rheinland Cert G
Am Gauen Stein · 51105
Germany

www.tuv.com



Certificate

Standard **IATF 16949:2016**
(1st edition, 2016-10-01)

Certificate Registr. No. **01 111 1532927**

IATF Certificate No. **0417000**

Certificate Holder: **Ruili Meilian Air Management Systems (Langfang) Co., Ltd.**
North Area, No. 2 Anzhong Road, Anci Economic Development
Zone, Langfang City, 065099 Hebei, P. R. China

Scope: **Design and Manufacturing of Air Compressors and Water Pump**

Proof has been furnished by means of an audit that the requirements of IATF 16949:2016 are met.

Validity: **The certificate is valid from 2021-08-12 until 2024-08-11.**

Release date: **2021-08-16**



24AO-QMC 01003

TÜV Rheinland Cert GmbH
Am Gauen Stein · 51105 Köln
Germany -NRW

www.tuv.com



1 / 2

CNAS certification



中国合格评定国家认可委员会 实验室认可证书

(注册号: CNAS L10315)

兹证明:

瑞立美联制动技术(廊坊)有限公司试验中心

河北省廊坊市安次经济开发区安中路 2 号北区, 065000

符合 ISO/IEC 17025:2005《检测和校准实验室能力的通用要求》(CNAS-CL01《检测和校准实验室能力认可准则》)的要求, 具备承担本证书附件所列服务能力, 予以认可。

获认可的能力范围见标有相同认可注册号的证书附件, 证书附件是本证书组成部分。

签发日期: 2017-09-22

有效期至: 2023-09-21

初次认可: 2017-09-22



中国合格评定国家认可委员会授权人

中国合格评定国家认可委员会(CNAS)经国家认证认可监督管理委员会(CNCA)授权, 依据《实验室认可规则》(CNAS-CL01)对符合 ISO/IEC 17025:2005 要求的实验室进行认证。CNAS 是国际实验室认可合作组织(ILAC)和亚太实验室认可合作组织(APLAC)的互认协议成员。本证书的有效性可登陆 www.cnas.org.cn 获认可的机构名称查询。



China National Accreditation Service for Conformity Assessment LABORATORY ACCREDITATION CERTIFICATE (Registration No. CNAS L10315)

Ruili Meilian Air Management Systems (Langfang) Co.,

Ltd. Test Center

**Northern Area, No.2, Anzhong Road, Anci Economic Development Area,
Langfang, Hebei, China**

is accredited in accordance with ISO/IEC 17025:2005 General Requirements for the Competence of Testing and Calibration Laboratories (CNAS-CL01 Accreditation Criteria for the Competence of Testing and Calibration Laboratories) for the competence to undertake the service described in the schedule attached to this certificate.

The scope of accreditation is detailed in the attached schedule bearing the same registration number as above. The schedule form an integral part of this certificate.

Date of issue: 2017-09-22

Date of Expiry: 2023-09-21

Date of Initial Accreditation: 2017-09-22

Signed on behalf of China National Accreditation Service for Conformity Assessment

China National Accreditation Service for Conformity Assessment (CNAS) is authorized by Certification and Accreditation Administration of the People's Republic of China (CNCA) to operate the national accreditation schemes for conformity assessment. CNAS is a signatory of the International Laboratory Accreditation Cooperation Mutual Recognition Arrangement (ILAC-MRA) and the Asia Pacific Laboratory Accreditation Cooperation Mutual Recognition Arrangement (APLAC-MRA). The validity of the certificate can be checked on CNAS website at <http://www.cnas.org.cn/english/evaluationoflabbody/index.shtml>

CONTENTS

AMERICAN APPLICATION	page
CATERPILLAR	01
CUMMINS	02 - 04
DETROIT	05
INTERNATIONAL NAVISTAR	06
JOHN DEERE	06
MACK	07

EUROPEAN APPLICATION	page
DAF	08 - 10
DEUTZ	10 - 11
IVECO	11 - 14
MAN	14 - 18
MERCEDES BENZ	18 - 25
PERKINS	26 - 27
RENAULT	28 - 29
SCANIA	30 - 32
VOLVO	32 - 35

JAPANESE APPLICATION	page
ISUZU	36
KOMATSU	36
MITSUBISHI	37

RUSSIA APPLICATION	page
UAZ	38
GAZ	38
MTZ	38
ZIL	38

CHINESE APPLICATION	page
WEICHAI	39 - 42
FAWDE	42 - 43
CUMMINS	43 - 44
DEUTZ	44
SINOTRUK	44

CATERPILLAR

CATERPILLAR

SORL NO.	ENGINE	OE NO.
 1307 051 104 0		1767000
 1307 051 105 0		2929252
 1307 051 106 0		7C4508
 1307 051 107 0	Caterpillar L6 14.6L(893)3406 B,3406C "Engrane Plano", Freightliner, Kenworth, Volvo, White (Aplicaciones automotrices) (1993-99)	7C4957 OR8217 10R0482 7W7019
 1307 051 114 0		3520205

SORL NO.	ENGINE	OE NO.
 1307 051 115 0	33043306	2W8002 1727766
 1307 051 116 0		2P0661 1727775
 1307 051 117 0		OR3007 4W0253 9Y4897 OR1013
 1307 051 118 0	Caterpillar 6L(893)3406E, "Engrane Campana", Freightliner, Kenworth, (2000-04)	613890 OR8218E 613890 OR4120 10R0483
 1307 051 119 0	Caterpillar 6L 893)3406E, "Engrane Campana", Freightliner, Kenworth, (2000-04)	613890 OR 8218E OR 4120 OR 0483



SORL NO.	ENGINE	OE NO.
 1307 040 003 0	BIG CAM IV 855 (MULTL GRV PULLEY)	3801708 3045943RX
 1307 040 004 0	BIG CAM 855 NTC 290,359,400 MULTI GRV LLEY	3801788 3022474
 1307 040 005 0	N41	3803605 3803361
 1307 040 006 0		4089910
 1307 040 009 0	M11 & L10 E SERIES 1991 AND LATER 3 HOLE MOUNT	3803403

SORL NO.	ENGINE	OE NO.
 1307 040 012 0	ISX 15	3684449(w/Housing)
 1307 040 013 0	ISX/ISZ	3684450 3683651
 1307 040 024 0	ISX	4089908
 1307 040 101 0	6CT8.3	3929612
 1307 040 110 0	6C 230 Series	3966841



SORL NO.	ENGINE	OE NO.	SORL NO.	ENGINE	OE NO.
 1307 040 111 0	B Series Diesel,(3.9L) 4 Cyl, 2374 Cyl. &(5.9L) 359 6 Cyl.	3802358 3903749 3802970 3913432 3802004 3286277 3286275 3285410	 1307 040 116 0		2853114
 1307 040 112 0	C Series(8.3L) Short Nose, FD1460 504 (8.3L) 6 Cyl.	3802081 3804883RX F3HZ8501B 3806180	 1307 040 117 0		3801840 3825540 3803402
 1307 040 113 0	CUMMINS B Series	3926203	 1307 040 118 0		3800975
 1307 040 114 0		4892175	 1307 040 119 0		3800974 3926912 3923568 3285323
 1307 040 115 0		2854835	 1307 040 120 0		3800976 3285324 3925540 3926914



SORL NO.	ENGINE	OE NO.
 1307 040 121 0		3804927 3940052 4089647
 1307 040 122 0		4089911
 1307 040 123 0		3800984
 1307 040 124 0	ISX/ISZ	3694449
 1307 040 125 0		

SORL NO.	ENGINE	OE NO.
 1307 040 126 0		3800745
 1307 040 127 0		3804826
 1307 040 128 0		
 1307 040 129 0	ISX/ISZ	3801708 304 594 3RX
 1307 040 130 0	WITH BACK COVER	



DETROIT
DEMAND PERFORMANCE



DETROIT
DEMAND PERFORMANCE

SORL NO.	ENGINE	OE NO.
 1307 039 002 0	60 Series	23522707 235326039 23505895 23518215 23520136 23522436
 1307 039 011 0	60 Series 14.01	25532542 AW2129 23530427 23531257 23535017
 1307 039 098 0		AW3717 1830607C4 1841764C2
 1307 039 099 0	60 Series 12.7L	AW2130 23 532 543 23 531 258 23 535 018
 1307 039 100 0	60 Series	23522721

SORL NO.	ENGINE	OE NO.
 1307 039 101 0	DD13/15	4722000001 4722000101 4722000401
 1307 039 102 0	8.2 LITER	8928672



JOHN DEERE

SORL NO.	ENGINE	OE NO.	SORL NO.	ENGINE	OE NO.
 1307 036 001 0	DT 360/414/415/46 6 DTA 360	1815538C91 735445C91 ZGA735327 P-476I	 1307 053 001 0		RE505980
 1307 036 007 0	DT 466	685155C91 685155C92 685155C94 685155C95 735327C91 P-476D	 1307 053 002 0		
 1307 036 021 0	DT 360/466	1817687C92 1817687C94 1817687C95 1817687C97 18179687C94 18179687C96 1821935C1 1821935C3 1830606C93 1830606C94 1817687C96			
 1307 036 022 0	DT 466 DT 466E	1842664C92			
 1307 036 023 0	Maxx Force13	7091873C1 3007644C94			



SORL NO.	ENGINE	OE NO.
 1307 045 029 0	L6	316GC284A
 1307 045 030 0	ENDT 675/676	316GC1184J
 1307 045 031 0	LE,MR,6-11.9 L	316GC3195
 1307 045 032 0	L6	
 1307 045 033 0		5001875237

SORL NO.	ENGINE	OE NO.
 1307 045 034 0	MP8	21228793 21468471 21468472 22197709 85109694 85116648 85124621 85142304 85110396 85116650 85124623

SORL NO.	ENGINE	OE NO.
 1307 046 040 0	80 95 95.330 95.460	0682968 0682258 0681653 372896
 1307 046 041 0	XF 85 XF 95 XF 355 XF 250M XF 280M XF 315M	0683225 0683386 9963225 1609871
 1307 046 042 0	600 800 1000 45ALL MODELS 55ALL MODELS	CBU2148 CBU2396 CBU1131 CBU1909 CBU2714 1399689
 1307 046 043 0	XE250C XE280C XE315C XE355C XE390C	0 683 579 1 609 853 1 399 150 1 399 336
 1307 046 044 0	1260 VS	1 778 280 1 664 762 1 828 162 0 931 147 1 653 974 1 742 258 1 742 259 1 747 962 1 747 963 1 828 141 1 828 142









SORL NO.	ENGINE	OE NO.
 1307 046 045 0	75CF 85XF	0683580 1441060 1609854
 1307 046 108 0	F65 F1100 F1300 F1700 F2300 65CF	0682958 0682271 0681460
 1307 046 112 0	PF183M PF212M PF235M	0683338
 1307 046 114 0	2100 2300 2500	0682263 0680217
 1307 046 115 0	3300	0682262 0680156

SORL NO.	ENGINE	OE NO.
 1307 046 116 0	2800 3300 3600	0682260 0517097 0506109 516724 288619
 1307 046 117 0	2100 2300 2500	0682264 0624147
 1307 046 118 0	F 2100 F 2300 F 2500	Repair kits
 1307 046 119 0	DT615	680520
 1307 046 120 0	865 RS	0682747

SORL NO.	ENGINE	OE NO.
 1307 046 121 0	ME EPA04	1942598 1859821
 1307 046 122 0	EURO 6CF, XF	1922223 1934326 1979914 1979951 1993418 1995152 2104574R
 1307 046 123 0	EURO 6CF, XF	2104577
 1307 046 124 0	EURO 6CF, XF	2104578
 1307 046 125 0	EURO 6CF, XF	1912939 1912939R 1917690 1945428 1953276 1956779 2042162R

SORL NO.	ENGINE	OE NO.
 1307 046 126 0	EURO 6CF,XF	1912940 2042161 2042161R
 1307 046 127 0	EURO 6CF,XF	2104575
 1307 046 128 0	EURO 6CF,XF	2104580 1956781 1949546 1953398
 1307 046 129 0	EURO 6CF,XF	2104576 2003494

SORL NO.	ENGINE	OE NO.
 1307 052 001 0	BF6M1013 TAD420/620 VE	0420 6747 21404508 21072752 20726081 22085821 21568086 3801236
 1307 052 002 0	BF6M1015 D7/5 D D8 H D9 B	0420 4095 21727935 21727941 21404504 21461866 20726083
 1307 052 003 0	BF6M1013 D4/5/6/7	0450 0930 21404502 21247955 21125771 20726092 20502535 20459004
 1307 052 004 0	D5 D TD520/720	0425 6959R 21727936 21461864 20726077 20405685
 1307 052 005 0	TD 63	1 131 121 11127755

SORL NO.	ENGINE	OE NO.	SORL NO.	ENGINE	OE NO.
 1307 052 006 0		0428 3172	 1307 044 025 0	8210.42	500350785 4253 0033 93190287 93190285 98447661 99445447 98479675
 1307 052 007 0			 1307 044 032 0	EURO TRAKKER EUROTECH CURSOR STRAILS	500356553
 1307 052 008 0		0425 6959R	 1307 044 046 0	8460.SPR Type: 6 cyl.9500cm3; 23Z	500350798 93190284 93190288
			 1307 044 047 0	8040.20 8040.05 8040.04 8040.24 8060.12 8040.02 8060.02	93191101 4679242 4639182 4655010 4655054
			 1307 044 048 0	8040.05 8040.25 8040.05 8060.05	98497117 98465322 4813370 98415712 4813371 4784454 504290853

IVECO

IVECO

SORL NO.	ENGINE	OE NO.
 1307 044 049 0	8210.42	Repair kits
 1307 044 050 0	8210.42	42530032 93190286 61315472 503475055
 1307 044 051 0	6CYL.7685	42535615 52532082
 1307 044 052 0	Daily 2006 M.Y	504087367
 1307 044 053 0	TECTOR 75E13	504062854 503662660









SORL NO.	ENGINE	OE NO.
 1307 044 054 0	EURO TRAKKER EUROTECH EUROMOV EREURO TRAKKER STRAILS	99483937 99460305 5001859590 504201935 5801931331 926371
 1307 044 055 0	CURSOR 8	504029280 5801702443
 1307 044 056 0	A35.12-A49.12- A59.12 A30.8-A35.8- A40.8 A35.10-A45.10- A49.10	500361919 99438900 500361203 98438356 99448068 500300476
 1307 044 057 0	315.8.18POK ER III 6CYL.5861CM3	98415831
 1307 044 058 0	190PC26- 190.26h 190PC30- PC190.30H 260PC26- 260.26H 33.30H 330PC26- 330.26H	4752137

IVECO

IVECO

SORL NO.	ENGINE	OE NO.
 1307 044 059 0	60.11-65.12-79.12 79.14-95.14-109.14 4SERIE 95.14 109.14 110.14P(4*4) 115.14-135.14-1 E2 SERIE	98497115 4835043
 1307 044 060 0		500362859 99479817
 1307 044 061 0	A35.12-A49.12-A59.12 A30.8- A35.8A40.8A35.10A45.10-A49.10	500362834 5001851798 500361455
 1307 044 062 0	A35.12-A49.12-A59.12 A30.8-A35.8-A40.8 A35.10-A45.10-A49.10	761312 4538058
 1307 044 063 0		504033770

SORL NO.	ENGINE	OE NO.
 1307 044 065 0		504113544
 1307 044 066 0		500300470 4812406
 1307 044 067 0		504248581 504102572
 1307 044 068 0		4752137
 1307 044 069 0		504360207

SORL NO.	ENGINE	OE NO.	SORL NO.	ENGINE	OE NO.
 1307 044 070 0		93190288	 1307 047 059 0	D 2865 D 2866 D 2876	51.06500-6426 51.06500-9426
 1307 044 071 0		4710552	 1307 047 060 0	D 2540 MTFMTH D 2566 MKUL D 2840 LE/LXF D 2865 LF/LFR/LXF/LX FR/LU D 2866 F/FR/TUH/TUM /UH/UM	51.06500-6408 51.06500-9408
 1307 044 072 0		4764156	 1307 047 061 0	D 0824 LFL01/02 /04 D 0824 LOH01 ~ 05 D 0826 LFL03/06 D 0824 LF01/02 D 0826 LOH15/17-19 D 0826 LF1/17/18	51.06500-6537 51.06500-9537
			 1307 047 062 0	D 0836 LFL 01-06 D 0836 LF 01/03-05 D 0834 LFL 01	51.06500-6606 51.06500-6612 51.06500-6575 51.06500-9606 51.06500-9612 51.06500-9575
			 1307 047 063 0	D 0824 LFO1/02 D 0826 LOH 01- 08 D 0826 LFG01/02/06 D 0826 LF/LF 217 LFO1/02/04-08	51.06500-6476 51.06500-9476 51.06500-6462 51.06500-9462



SORL NO.	ENGINE	OE NO.
 1307 047 064 0	D 2865 LF D 2866 LF D 2876 LF F2000 SERIES	51.06500-6546 51.06500-9546
 1307 047 065 0	D 0836 LFL 01-06 D 0836 LF 01/03-05 D 0834 LFL 01	Repair kits 51.06599-6081 for pumps: 51.06500-6606 51.06500-6612 51.06500-6575
 1307 047 066 0	D 2566 D 2840 D 2865 D 2866 D 2876 for pumps: 51 06500 6492, 51 06500 6490, 51 06500 6479, 51 06500 6545, 51 06500 6546.	Repair kits 51.06599-6013
 1307 047 067 0	18363 ECT D2876LF05 D2876LF13 D2876LF12	51.06500-9066 51.06500-7045 51.06500-7047 51.06500-7048 51.06500-7065 51.06500-7066 51.06500-9048 51.06500-9052 51.06500-7052 51.06500-7033 51.06500-7036
 1307 047 068 0	D 2865 D 2866 D 2876	Repair kits 51.06599-6033 51.06599-6010 51.06599-6011 51.06599-6012 51.06599-6035 for pumps: 51.06500.6426, 51.06500.6282, 51.06500.6492, 51.06500.6228

SORL NO.	ENGINE	OE NO.
 1307 047 069 0	MAN TGA D20 D 2066 B 2076	51.06500-7049 51.06500-6637 51.06500-9049
 1307 047 070 0	F 2000 serie	51.06500-6547 51.06500-9547
 1307 047 071 0	D 0824 LOH01/02/03/04/05, D 0826 LFL03/06-10, D 2824 FL01, D 2824 LFG01/02/06, D 0824 LFL01/02/04-10 LFO-01, D 2824 LFL09/10, D 2826 LFL03/06-D0836	51.06500-6515 51.06500-6532 51.06500-9515 51.06500-9532
 1307 047 072 0	LF13/41/43/4, D0836 LOH40/41/50, D0836 LFL40/41/44, D0834 LFL40/41/42, D0834 LFL50-55/57, D0836 LFL50-55.	51.06500-6679 51.06500-7078 51.06500-7064 51.06500-9078 51.06500-9064 51.06500-6699 51.06500-9699 51.06500-9679
 1307 047 073 0		Repair kits 51.06599-6086 R WITHOUT CLIP-RING & FLANGE for pumps: 51.06500-7049 51.06500-6637 51.06500-9049



SORL NO.	ENGINE	OE NO.
 1307 047 074 0	D2066 LF01-04/6/7/11-20/21-39, D2066 LF01 (USA), D2676 LF01-5/11-16; V55 00, V55 02, V73 00	51.06500-6642 51.06500-9642 51.06500-6675 51.06500-9675 51.06500-9694
 1307 047 084 0	D 0824 LFL 01/0204 D 0824 LOH 01-05 D 0826 LFL 0306 D 0824 LF01/02 D 0826 LOH15/17-19 D 0826 LF1/17/18	Repair kits 51.06599-6067
 1307 047 101 0	D 2865 D 2866 D 2876	51.06500-6479 51.06500-9479
 1307 047 102 0	D 2530 D 2538 D 2565 D 2566 D 2866 F/FR/TUH/TUM /UH/UM	51.06500-6282 51.06500-6387 51.06500-9282 51.06500-9387
 1307 047 103 0	D 2530 D 2538 D 2565 D 2566	51.06500-6228 51.06500-6229 51.06500-6225 51.06500-6224 51.06500-6223 51.06500-6222 51.06500-6221 51.06500-6219 51.06500-6218 51.06500-6216 51.06500-6215

SORL NO.	ENGINE	OE NO.
 1307 047 104 0	D 0826 LOH 01-08 D 0826 LF/LF 217/LF01/02/04 ~08 D2865 LF21/22/23	51.06500-6495 51.06500-6463 51.06500-9495 51.06500-3178 51.06500-6463
 1307 047 105 0	D 0824 LF 01/02 D0826 LOH 01-08 D 0826 LFG 01/02/06 D 0826 LF/LF 217 LF01/02/04-08	Repair kits 51.06500-6052
 1307 047 106 0	F 2000 serie	51.06500-6548 51.06500-9548
 1307 047 107 0	F 90 serie F 2000 serie	51.06500-6492
 1307 047 108 0	D 2842 D 2840	51.06500-6472 51.06500-6458 51.06500-6281 51.06500-9472



SORL NO.	ENGINE	OE NO.
 1307 047 109 0	D 0826	51.06500-6480 51.06500-9480
 1307 047 110 0	D 0826	51.06500-6543 51.06500-9543 51.06500-6569 51.06500-9569
 1307 047 111 0	D 2066 D 2676	51.06500-6676 51.06500-6646 51.06500-9646 51.06500-9050
 1307 047 112 0	D 0836 D 0834	51.06500-6680 51.06500-7070 51.06500-7079 51.06500-9079 51.06500-6651 51.06500-9651 51.06500-9680
 1307 047 113 0		Repair kits 51.06599-6055

SORL NO.	ENGINE	OE NO.
 1307 047 114 0		Repair kits
 1307 047 115 0		Repair kits 51.06599-6091
 1307 047 116 0	D 0836 D 0834	51.06500-6587 51.06500-6594 51.06500-9587
 1307 047 117 0	ENVIRO 400 EURO 5	51.06500-6673 51.06500-9673 51.06500-9692 51.06500-6692
 1307 047 118 0	EURO 5	51.06500-6674 51.06500-9698 51.06500-9674 51.06500-9668 51.06500-6698 51.06500-6668



SORL NO.	ENGINE	OE NO.
 1307 047 119 0	EURO 4 FOR MN133 FOR MN125	51.06330-5040 51.06500-5034
 1307 047 120 0		51.06330-5048 51.06330-5019
 1307 047 121 0		95.06500-6148-5
 1307 047 122 0		
 1307 047 123 0		51.06330-5047 51.06330-3035











SORL NO.	ENGINE	OE NO.
 1307 043 022 0	904 4 cylinder electric	24206 613 200 0701
 1307 043 023 0	906la	24207 906 200 4201 906 200 3201 906 200 5701
 1307 043 026 0	OM 457/LA	457 200 0101 457 200 0201 457 200 0101
 1307 043 027 0	OM 457 OM 458	457 200 0501 457 200 0201 457 200 2501 457 200 1101 457 200 2701 457 200 7001
 1307 043 033 0		20200179













SORL NO.	ENGINE	OE NO.
 1307 043 034 0	OM 401-404 OM 401 LA OM 402 LA OM 407/A/hA/h OM 409 OM 421-424/A/LA OM 427-429 OM 441-444/A/LA OM 447-449	403 200 7101 403 200 5101 403 200 4401
 1307 043 035 0	OM 442 OM 447	422 200 1201 422 200 0701
 1307 043 047 0	OM 364/A/LA Type: R4, 97,5 plastic impeller	364 200 2001 364 200 0101 364 200 0901
 1307 043 048 0	OM 501 LA OM 502 LA Type: V 6/8, 130; Actros, for engine: 019798, with retarder	542 200 2001 542 200 1601 542 200 0601
 1307 043 050 0	OM 401-404 OM 401 LA OM 402 LA OM 407/A/hA/h OM 409 OM 421-424/A/LA OM 427-429 OM 441-444/A/LA OM 447-449	403 200 7601 403 200 7701

SORL NO.	ENGINE	OE NO.
 1307 043 049 0	OM 401-404/A/LA OM 421-424/A/LA OM 441-444/A/LA	Repair kits: 422 200 0604 422 200 0104 422 200 0304 422 200 0104 422 200 0120 423 200 0104 for pumps: 403 200 4901, 403 200 5101, 403 200 5301, 403 200 7001, 403 200 7701
 1307 043 051 0	OM 501 LA OM 502 LA	542 200 1901 542 200 1501 542 200 0501
 1307 043 052 0	OM 501 LA OM 502 LA	541 200 1201 541 200 1101 541 200 0101
 1307 043 053 0	OM 904/906LA Type: R 4/6	904 200 4901 904 200 2601 904 200 2001 904 200 0801 904 200 0401 904 200 2801 904 200 4301 904 200 2201







SORL NO.	ENGINE	OE NO.	SORL NO.	ENGINE	OE NO.
 1307 043 054 0	OM 366/A/LA	366 200 5901 366 200 0901 366 200 0401 366 200 0701 376 200 0701	 1307 043 094 0	OM 364 OM 352	353 200 0401 353 200 3601 353 200 0301 353 200 3801 353 200 7401 353 200 8401 353 200 9401
 1307 043 055 0	OM 904/906LA	Repair kits 904 200 0004 906 200 0004 for pumps: 9042004901, 904 200 2601, 904 200 2001, 904 200 0801, 904 200 0401	 1307 043 095 0		376 201 0001
 1307 043 056 0	OM 364/A/LA	Repair kits 364 200 0804 364 200 0504 364 200 0304 for pumps: 3642002001, 364 200 0101, 364 200 0901	 1307 043 096 0		906 200 0901
 1307 043 057 0	OM 904 LA OM 906 LA	906 200 6101 906 200 5401 906 200 2901 906 200 2201 906 200 1401 906 200 4801 906 200 6501	 1307 043 097 0	OM 906 LA OM 924 LA OM 926 LA	906 200 4001 906 200 5101 906 200 4301 906 200 6301 aftermarket
 1307 043 058 0	OM 457 OM 458	457 200 0801 457 200 2301 457 200 2901	 1307 043 102 0		4.62587SP



SORL NO.	ENGINE	OE NO.	SORL NO.	ENGINE	OE NO.
 1307 043 103 0		4.66325 3142000801	 1307 043 108 0	OM 366/A/LA	
 1307 043 104 0	OM355/A	355 200 0801 345 200 0901 355 200 1501 355 200 1101 355 200 0901 355 200 0501 355 200 0801 355 200 0601 355 200 0101	 1307 043 109 0	OM 366/A/LA	
 1307 043 105 0	OM 314	314 200 4701 314 200 4101	 1307 043 110 0	OM 401 OM 402 OM 403 OM 407 OM 421 OM 422 OM 423 OM 424 OM 427 OM 441 OM 442	422 200 1101 422 200 0601
 1307 043 106 0	OM 314	314 200 4201 314 200 3901 314 200 3701 314 200 2901 314 200 2401 314 200 1901 314 200 0801	 1307 043 111 0	OM 422/442 OM 423/443 OM 404/444	422 200 1001 422 200 0501
 1307 043 107 0	OM 355/A	355 200 0801 345 200 0901 355 200 1501 355 200 1101 355 200 0901 355 200 0501 355 200 0801 355 200 0601 355 200 0101	 1307 043 112 0	OM 407-409 OM 427-429 A/H/LA OM 447-449 A/H/LA	Repair kits 422 200 0404 422 200 0204













SORL NO.	ENGINE	OE NO.
 1307 043 113 0	OM 501LA OM 502LA	Repair kits 542 200 0104 542 200 0004
 1307 043 114 0	WITH METAL GASKET	Repair kits 5422000104
 1307 043 115 0	Famsa L6 OM366 Turbocargado L6 con Post enfriador(1979- 92) Autobus OF-1318/5, OF-1318/U,OF- 1418/51Fam sa L6 OM366	366 200 0501 366 200 1501 366 200 2201 366 200 6001
 1307 043 116 0	OM 401-404 OM 407/A/hA/h OM 409	403 200 7001 403 200 4901 403 200 3501 403 200 2701 403 200 3201 403 200 3401
 1307 043 117 0	OM 407 H OM 422 OM 427 H/HA OM 441 OM 447 HA	403 200 7301 403 200 5301

SORL NO.	ENGINE	OE NO.
 1307 043 118 0	OM 441/442/A/LA	441 200 0201 441 200 0101
 1307 043 119 0	OM 366	366 200 6801 366 200 0001 366 200 0901 366 200 6701 366 200 5501 366 200 5401
 1307 043 120 0	OM 366	366 200 6801X
 1307 043 121 0	OM 441 OM 442	Repair kits 441 200 0204 441 200 0104
 1307 043 122 0	OM 355	Repair kits 355 200 1204 355 200 0804

WATER PUMP FOR EUROPEAN COMMERCIAL VEHICLES













SORL NO.	ENGINE	OE NO.	SORL NO.	ENGINE	OE NO.
 1307 043 123 0	OM 366 OM 366 A OM 366 LA OM 366 LA Eruo II	Repair kits 366 200 0804 366 200 0604 366 200 0304 366 200 0004 for pumps: 366 200 5901, 366 200 0901, 366 200 0401	 1307 043 128 0	WITHOUT COVER	353 2005 601X
 1307 043 124 0	OM 314	Repair kits 314 200 1004 314 200 0704	 1307 043 129 0	OM 352	353 200 2101 353 200 3701
 1307 043 125 0	OM 501 LA OM 502 LA	Repair kits 541 200 0004	 1307 043 130 0	OM 352	Repair kits 352 200 4404 352 200 4304
 1307 043 126 0	OM 904 LA OM 906 LA	292761	 1307 043 130 0	OM 352	Repair kits 352 200 3804
 1307 043 127 0	OM 364 OM 352	353 200 5601 352 200 9501 352 200 9701 353 200 1701	 1307 043 132 0	OM 352	Repair kits 352 200 4104 352 200 4504



SORL NO.	ENGINE	OE NO.
 1307 043 133 0	OM 501 LA OM 502 LA	542 200 2301 541 200 0901
 1307 043 134 0	OM 501 LA OM 502 LA	542 200 2401
 1307 043 135 0	OM 637	376 200 0001 376 200 0401 376 200 0501 376 200 0601
 1307 043 136 0	OM 355 OM 355/A	Repair kits 355 200 1304 355 200 0904 355 200 0404
 1307 043 137 0	OM 457 OM 458	457 200 0004 457 200 0104

SORL NO.	ENGINE	OE NO.
 1307 043 138 0	OM 457 OM 458	457 200 1001 457 200 2401 457 200 0901
 1307 043 139 0	OM 401/A OM 402/A OM 403 OM 407AH/LA OM 421/A/LA OM 422/A/LA OM 423/A/LA OM 424/A/LA OM 427/AH/LA OM 442/A/LA OM 443	422 200 1401
 1307 043 140 0	OM 423	403 200 7501
 1307 043 141 0	Actros	542 200 2201 542 200 1801
 1307 043 142 0	Actros	542 200 2101 542 200 1701













SORL NO.	ENGINE	OE NO.	SORL NO.	ENGINE	OE NO.
 1307 043 143 0	Actros	Repair kits	 1307 043 148 0		906 200 4001 906 200 5101 906 200 4301
 1307 043 144 0		460 200 0001	 1307 043 149 0		541 200 2801
 1307 043 145 0	OM 906 HLA	906 200 6001 906 200 2701 906 200 5201 906 200 2601	 1307 043 150 0	HUB 114mm	904 200 4901
 1307 043 146 0	OM 906 LA OM 924 LA OM 926 LA		 1307 043 151 0	1307 043 027 0 HOUSING+ 141.5MM PULLEY	
 1307 043 147 0		906 200 6201 906 200 4901 906 200 5501 906 200 3701 906 200 2801	 1307 043 163 0		906 200 4001 906 200 5101 906 200 4301 906 200 6301 original



Perkins®



Perkins®

SORL NO.	ENGINE	OE NO.	SORL NO.	ENGINE	OE NO.
 1307 054 001 0	PHSAER 90	3771004/7	 1307 054 006 0		37773799
 1307 054 002 0	TURBO 900		 1307 054 007 0	MOTOR 4.203,4.248,1.2 36 MASSY FURG USON Mf165	41312167 41312063 41312574 U5MW0061
 1307 054 003 0			 1307 054 008 0		413A062 U5WM0194 U5WM0206
 1307 054 004 0	6.354.4 A6.354.4 T6.354.4 6.372.4 A6.372.4	41313065 U5MW0129	 1307 054 009 0		
 1307 054 005 0	MOTER 4.236	41313201 41312143 41313237 41312201 41312323 U5WM0108 M743064	 1307 054 010 0	Perkins L9 6354(5.8L) (19 68-92) Dina Fase I1,531 Ford F600,GM C50, C60,New HollandTractor.	U5WM0111 P105



SORL NO.	ENGINE	OE NO.
 1307 054 011 0		41312784
 1307 054 012 0		41312154 41312159 41312487
 1307 054 013 0		
 1307 054 014 0		U5WM0193
 1307 054 015 0		145017951

SORL NO.	ENGINE	OE NO.
 1307 054 016 0	C6.6	3544754
 1307 054 017 0		U5WM0204 U5WM0207
 1307 054 018 0		U45010062



RENAULT

SORL NO.	ENGINE	OE NO.
 1307 048 075 0	PREMIUM FA B22CC TRACTEUR	5001858484 5001857427 5001585005 5010550552 5010477162 5010477321 5010477734 5010550550
 1307 048 076 0	M140- M160MIDR 0620.45B M200- M230MIDS 062045B S140-S160 PS150-PS160 S 170	5600409620 5010258977 2001837288
 1307 048 077 0	MIDR 06.20.45 MIDR 06.20.30	5010330029 5001837265
 1307 048 078 0	MIDR 062 465	5001837331 5001870446 5001845328 5200538288 5010284179 2010438102 316GC3195
 1307 048 079 0	C210-CLR220 MIDR 06.20.045 C230-C260MI DR 06.20.045 E/3 C280-C290 C300-CCH300 C340T1 G210-G220 R312-G320 R310-R330	5000670157 5001837298 5000681283



RENAULT

SORL NO.	ENGINE	OE NO.
 1307 048 080 0	C210-19MIDS 06.20.30 G210.17- G210.1 9MIDS 06.20.45 G230.17- G230.1 9MIDR 06.20.45 CLR 220 G260.11- G260.13	5000663121 5001837295
 1307 048 081 0	PR 10S S MIDS 6.20.30 PR 12 S MIP 06.20.30 PR 14 S/640 MI PS 06.20.30 PR 14 S/641 PG 60-G45-G 105 PR 100 MI PR 180	5000663009
 1307 048 082 0	MAGNUM MD IR06.35.40 AE380-AE420 MDR 06.35.A R385 MAJOR- 385 TI R420 MAJOR- 420TI	5010248921 5101837322
 1307 048 083 0	R310-R330 MD 06.35.40 R340-R365 MDS 06.35.40 CBH280- CBH340 MIDS 06.35.40 AE380-AE420 MDR 06.35.40 R385MAJOR- 385	5010323187 5001837314
 1307 048 084 0	D2566 D2530 D2538	5000286186



RENAULT

SORL NO.	ENGINE	OE NO.
 1307 048 085 0	GR251-TR251D 2566 MTSF PS30-Hi38	5000281838 5000280678
 1307 048 086 0	DXI 11	7420744940 7485000763 7420538845 7420744939
 1307 048 087 0	MAGNUM DX112 DX113	5001866 278 7420734268
 1307 048 088 0	M140- M160MIDR 06.20.45B M200- M230MIDS 06.20.45B S140-S160 PS150-PS160 S 170	5010258978 5001837292 5010450735
 1307 048 089 0		5001849884 5001837268



RENAULT

SORL NO.	ENGINE	OE NO.
 1307 048 090 0		5000297602 5001837265
 1307 048 091 0	TD 520 TD 720	7420834409 7420997647 7420997650
 1307 048 092 0		5001863728 5001863754 5001875237 7485003149
 1307 048 093 0		5001837322 5010248921 5010553652



SORL NO.	ENGINE	OE NO.
 1307 041 019 0	DSC 13, 6cyl. 12700 cc R 400, R 440, R 480	1778923 570193
 1307 041 030 0	DS 11 DSC 11 DN 11 DS 11 DSC 11 DTC 11	1314406 1575100 1571059 575100 571059 292761 290865 524866
 1307 041 031 0	DC 9/19/20/21 D 9/11/12	1789522 1546188 570964 570959 1787123
 1307 041 079 0	DSC 11 DSC 12 D 9/11/12 DC 9/19	1508533 1353072 570951 570955 1372365 1896752 570962
 1307 041 080 0	DSC 13, 6cyl. 12700 cc R 400, R 440, R 480	1778923 570193

SORL NO.	ENGINE	OE NO.
 1307 041 087 0	DC 9	1510490 1486098 1380897 570957 570953 571157 570961
 1307 041 088 0	DN 9 DS 9 DSC 9L DS 9B DSC 9B	1338490 1377571 571067 571066 397957 369902 347963 571065
 1307 041 092 0	D 13 DC 13 D 9	2224112 2034084 2006397 1884327 1789555 576662 576665 570194
 1307 041 093 0	DS 11 DSC 11 DN 11 DS 11 DSC 11 DTC 11	Repair kits
 1307 041 094 0	D 11 DS 11	259065 571055 258263 235310 228826



SORL NO.	ENGINE	OE NO.
 1307 041 095 0	DSC 14 D 14	1508534 1365841 1365481 570952 570956
 1307 041 096 0	DS 11 DSC 11 DN 11 DTC 11	Repair kits 550 167
 1307 041 097 0	DS 11 DSC 11 DN 11 DTC 11	Repair kits 550044
 1307 041 098 0	R/T143	320592 292762
 1307 041 099 0	R/T143	320592 292762











SORL NO.	ENGINE	OE NO.
 1307 041 100 0		FAN MOUNT
 1307 041 101 0		1354103 1314336 571150 1354403
 1307 041 102 0		Repair kits 550167
 1307 041 103 0		Repair kits 550142+550044
 1307 041 104 0		Repair kits 550206+551476



SORL NO.	ENGINE	OE NO.
 1307 041 105 0	DSC 11 DSC 12	Repair kits 551355
 1307 041 106 0	DSC 14	Repair kits 551369
 1307 041 107 0	D16/A/M DSC 16	1549482 1793989 570958 570954 570881
 1307 041 108 0	FOR SC119	1528348 1787121
 1307 041 109 0	FOR SC104	1450153 1376495

SORL NO.	ENGINE	OE NO.
 1307 041 110 0	DSC 14	1375839 1375840 1362261 571154 571155
 1307 041 111 0		1787120 970965
 1307 041 112 0	D 13 DC 13 D 9	16625769
 1307 041 113 0	FOR SC118	1793990 1423397











SORL NO.	ENGINE	OE NO.	SORL NO.	ENGINE	OE NO.
 1307 042 028 0	TD101/102/103 TD121/122/123	20431484 1545261 8149937 1699790 1698620 1675945 479931 478845 422791 3184802	 1307 042 082 0	TD 61 TD 63 D 7 D 6 TD 71 TD 73	8192050 3183908 477770 20575653 3183909 8112185 85000387
 1307 042 036 0	D 12A	8149941 8148460 8113117 1547155 8112275 1001698	 1307 042 083 0	D 9A	2053845 20744939 21468471 21228793 85000486 20761306
 1307 042 037 0	D 12C	8170305 8113274 98200114A	 1307 042 084 0	TD 61 TD 63 D 7 D 6 TD 71 TD 73	Repair kits 85107763 276835 276803 276054 276942
 1307 042 038 0		98200124 22902431 7422902432	 1307 042 085 0	N 10TD 101G N 10TD 100G	Repair kits 276 800
 1307 042 039 0	D 12A	20431135 20713787 20734268 8170833 20431151 20431137 8113274 85000452 20713954 85000076 8113275	 1307 042 086 0	D 12A D 12B	8149882 1676713 8113155 8112889



SORL NO.	ENGINE	OE NO.	SORL NO.	ENGINE	OE NO.
<p>1307 042 087 0</p>	TD 101 TD 121	Repair kits	<p>1307 042 092 0</p>	D 9	3161436 85000062 3803930 3803844 3801484
<p>1307 042 088 0</p>	TD 102 TD 122	Repair kits 270 791 275 615 2768 02	<p>1307 042 093 0</p>	TD520 GE TD720 GE	20834409 20997647 20997650 21417491 3801244 3801164 85003894
<p>1307 042 089 0</p>	TD 103 TD 123	Repair kits 276 814	<p>1307 042 094 0</p>		
<p>1307 042 090 0</p>		Repair kits	<p>1307 042 095 0</p>		Repair kits 98582037
<p>1307 042 091 0</p>	D 9A D 9B	20857085 20411880 85000214 21076088	<p>1307 042 096 0</p>		Repair kits 98582038



SORL NO.	ENGINE	OE NO.	SORL NO.	ENGINE	OE NO.
 1307 042 097 0		Repair kits	 1307 042 102 0	FOR VL117	20431584
 1307 042 098 0		Repair kits	 1307 042 103 0	EURO 5 EURO 6 D11K D11C	21812242 21974080 21648708 21969187 21969188 21648716 21648712 20921947
 1307 042 099 0			 1307 042 104 0	EURO 5 D13C EURO 6 D13K	212900900 21969183 21648708 21030340 20920085 85013466 85013425 85013056 85000956 21960479 21814009
 1307 042 100 0	TD 100 TD 101 TD 102	1699788 1545248 1698618 467907 467686 8112521			
 1307 042 101 0	FOR VL116 FOR VL137	22195464 21284318 20505543 85003269			

ISUZU

KOMATSU

SORL NO.	ENGINE	OE NO.
 1307 050 099 0	6HE1-TC	8943934473
 1307 050 100 0	4JG11	8-94140341-1
 1307 050 101 0	EX300-5	1-13650068-1
 1307 050 102 0	4JJ1 EX	8980228220
 1307 050 103 0	4JJ1 SH	8980476893

SORL NO.	ENGINE	OE NO.
 1307 056 001 0	6D95L	6209-61-1100
 1307 056 002 0	S6D95	6206-61-1100
 1307 056 003 0	4TNV98	12990042050 12990042055
 1307 056 004 0	6D108 8Groove	6222631200
 1307 056 005 0	6D108 4Groove	6221611102



SORL NO.	ENGINE	OE NO.	SORL NO.	ENGINE	OE NO.
 1307 057 001 0	6D16T	ME995307			
 1307 057 002 0	6D24	ME158623			
 1307 057 003 0	SK130-8	VA32G4521010			
 1307 057 004 0	6D22 Engine oil	ME150295			



SORL NO.	ENGINE	OE NO.
 1307 0550010	UAZ/YAZ	
 1307 055 002 0	GAZ/YAZ	
 1307 055 003 0	MTZ/MT3	240-1307010-A
 1307 055 004 0	ZIL	
 1307 055 005 0	T25-1403101	BT3

SORL NO.	ENGINE	OE NO.
 1307 055 006 0	MTZ/MT3(36 Gears)	240-1403010-02
 1307 055 007 0	GAZ/FA3VS	



WEICHAI
潍柴

SORL	APPLICATION	Host number
PY00849	WeiChai	612600061603



WEICHAI
潍柴

SORL	APPLICATION	Host number
PY00852	WeiChai	612600060389



WEICHAI
潍柴

SORL	APPLICATION	Host number
PY00853	WeiChai	61560060050



WEICHAI
潍柴

SORL	APPLICATION	Host number
PY00855	WeiChai	612600061700



WEICHAI
潍柴

SORL	APPLICATION	Host number
PY00885	WeiChai	612600061364



WEICHAI
潍柴

SORL	APPLICATION	Host number
PY00887	WeiChai	612600061359



WEICHAI
潍柴

SORL	APPLICATION	Host number
PY00881	WeiChai	612600061400



WEICHAI
潍柴

SORL	APPLICATION	Host number
PY00874	WeiChai	1000173871



WEICHAI
潍柴

SORL	APPLICATION	Host number
PY00876	WeiChai	1000873618



WEICHAI
潍柴

SORL	APPLICATION	Host number
PY00865	WeiChai	612630061257



WEICHAI
潍柴

SORL	APPLICATION	Host number
PY00875	WeiChai	1000103510



WEICHAI
潍柴

SORL	APPLICATION	Host number
PY00886	WeiChai	612600061296



WEICHAI
潍柴



SORL	APPLICATION	Host number
PY00890	WeiChai	612600061945

WEICHAI
潍柴



SORL	APPLICATION	Host number
PY00869	WeiChai	1000588402

WEICHAI
潍柴



SORL	APPLICATION	Host number
PY00872	WeiChai	1000804128

WEICHAI
潍柴



SORL	APPLICATION	Host number
PY00868	WeiChai	1000437469

WEICHAI
潍柴



SORL	APPLICATION	Host number
PY00873	WeiChai	1001786118

WEICHAI
潍柴



SORL	APPLICATION	Host number
PY00888	WeiChai	612600060307

WEICHAI
潍柴



SORL	APPLICATION	Host number
PY00878	WeiChai	612600061739

WEICHAI
潍柴



SORL	APPLICATION	Host number
PY00877	WeiChai	611600060006

WEICHAI
潍柴



SORL	APPLICATION	Host number
PY00864	WeiChai	1000402861

WEICHAI
潍柴



SORL	APPLICATION	Host number
PY00883	WeiChai	612630061042

WEICHAI
潍柴



SORL	APPLICATION	Host number
PY00916	WeiChai	612600061611

WEICHAI
潍柴



SORL	APPLICATION	Host number
PY00911	WeiChai	1001273037



SORL	APPLICATION	Host number
PY00917	WeiChai	612600060465



SORL	APPLICATION	Host number
PY00944	WeiChai	1003374138



SORL	APPLICATION	Host number
PY00945	WeiChai	1003419484



SORL	APPLICATION	Host number
PY00862	WeiChai	612640060102



SORL	APPLICATION	Host number
PY00918	WeiChai	612640060230



SORL	APPLICATION	Host number
PY00978	WeiChai	1002123784



SORL	APPLICATION	Host number
PY00979	WeiChai	1003431855



SORL	APPLICATION	Host number
PY00969	WeiChai	612630061139



SORL	APPLICATION	Host number
PY00989	WeiChai	612600061498



SORL	APPLICATION	Host number
PY00990	WeiChai	612600061497



SORL	APPLICATION	Host number
PY00992	WeiChai	612600061578



SORL	APPLICATION	Host number
PY00993	WeiChai	612600060726



WEICHAI
潍柴



SORL	APPLICATION	Host number
PY00946	WeiChai	1307010A630-1148A

WEICHAI
潍柴



SORL	APPLICATION	Host number
PY00960	WeiChai	612600061574

WEICHAI
潍柴



SORL	APPLICATION	Host number
PY00968	WeiChai	612600061666

WEICHAI
潍柴



SORL	APPLICATION	Host number
PY00996	WeiChai	61800061007

WEICHAI
潍柴



SORL	APPLICATION	Host number
PY00997	WeiChai	612600060569

WEICHAI
潍柴



SORL	APPLICATION	Host number
PY00967	WeiChai	612600062191

WEICHAI
潍柴



SORL	APPLICATION	Host number
PY00965	WeiChai	612600061403

WEICHAI
潍柴



SORL	APPLICATION	Host number
PY00973	WeiChai	612600061728

WEICHAI
潍柴



SORL	APPLICATION	Host number
PY00974	WeiChai	612600061937

WEICHAI
潍柴



SORL	APPLICATION	Host number
PY00961	WeiChai	612600062018

一汽锡柴



SORL	APPLICATION	Host number
PY00844	FAWDE	1307010-29D

一汽锡柴



SORL	APPLICATION	Host number
PY00857	FAWDE	1307010-640-0000H

WATER PUMP FOR CHINESE COMMERCIAL VEHICLES



一汽锡柴



SORL	APPLICATION	Host number
PY00889	FAWDE	1307010-81D



一汽锡柴



SORL	APPLICATION	Host number
PY00891	FAWDE	1307010-B29D



一汽锡柴



SORL	APPLICATION	Host number
PY00884	FAWDE	1307010-36D



一汽锡柴



SORL	APPLICATION	Host number
PY00901	FAWDE	A1307010-M50-0000H



一汽锡柴



SORL	APPLICATION	Host number
PY00906	FAWDE	1307010-M18-099VH



一汽锡柴



SORL	APPLICATION	Host number
PY00903	FAWDE	1307010-M10-01085



一汽锡柴



SORL	APPLICATION	Host number
PY00907	FAWDE	1307010-M39-0E1901



一汽锡柴



SORL	APPLICATION	Host number
PY00904	FAWDE	1307010A6A0-206DAHC



一汽锡柴



SORL	APPLICATION	Host number
PY00905	FAWDE	1307010A96E



一汽锡柴



SORL	APPLICATION	Host number
PY00915	FAWDE	1307010BL00-0000



康明斯



SORL	APPLICATION	Host number
PY00920	Cummins	C4934058



康明斯



SORL	APPLICATION	Host number
PY00923	Cummins	C3966841



SORL	APPLICATION	Host number
PY00925	Cummins	A3960342



SORL	APPLICATION	Host number
PY00937	DEUTZ	1307010-40FY-D



SORL	APPLICATION	Host number
PY00939	DEUTZ	1307010A56D-B



SORL	APPLICATION	Host number
PY00919	SFH	(C13)FAT5801590769



SORL	APPLICATION	Host number
PY00848	SINOTRUK	VG1500060051



SORL	APPLICATION	Host number
PY00858	SINOTRUK	AZ1500060050



SORL	APPLICATION	Host number
PY00861	SINOTRUK	VG1062060351



SORL	APPLICATION	Host number
PY00910	SINOTRUK	200V06500-6694